



ROVER 23.6" COMMERCIAL LED
CCTV MONITOR, (AHD,TVI,CVI) MULTI-FORMAT
350 CD/M², BNC, VGA, HDMI,
PLASTIC CASE
ROD24B33



FEATURES

- Industrial level DID LCD panel, suitable for extensive 24/7 continuous operation;
- Resolution: 1920 x 1080;
- Support TVI (4MP/5MP) Cameras: 50M;
- Support AHD(4MP/5MP)Cameras: 500M;
- Support CVI (2MP/4MP)Cameras: 200M;
- High fidelity digital processing, brilliant and vivid video;
- 3D Digital Noise Reduction Technology;
- Convenient Controller and Menu;

DIMENSION

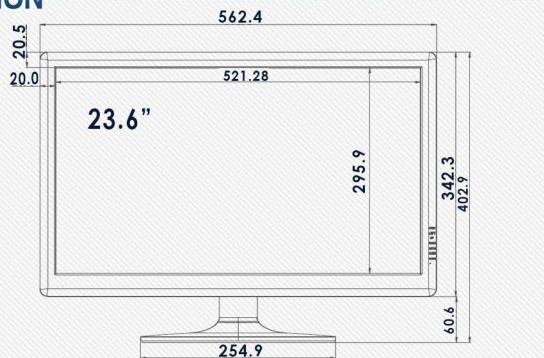

Unit:mm

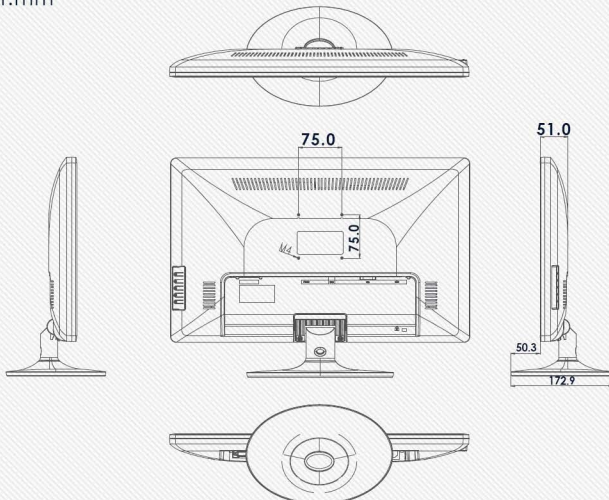

SPECIFICATIONS

MODEL	ROD24B33
MONITOR	
Screen Size	23.6"
Screen Size with Bezel	24"
Active Display Area (mm)	521.28mm(W)×293.22mm(H)
Display Mode	4:3, Point to point (VGA and HDMI)
LED Type	TFT-LED
Resolution	1920X1080
Display Color	16.7M
Pixel Pitch (mm)	0.248(H)×0.248(V)
Brightness (nits)	350cd/m ²
Contrast Ratio	1000:1
Viewing Angle	178(H) /178(V)
Response Time	5ms
Backlight	LED
INPUT	
HDMI 2.0	1
VGA	1
BNC Output	1 (Add BNC Extender)
BNC Input	1
AHD/TVI/CVI/CVBS	Support
VIDEO	
Color System	NTSC, PAL
OSD	Auto adjust, Brightness, Contrast, Horizontal / Vertical. Position, Clock,phase, Color, Language
3D Comb Filter	Supported
Video Noise Reduction	Supported
POWER & MOUNTING	
Power	DC12V~24V,50/60Hz
Working Temperature	-30 to +85 °C
Power Consumption	<25W
Menu	English
Mounting	Stand mount, VESA mount
MTBF	50000 Hours
ACCESSORIES	
Included Accessories	Remote control industrial PSU,Screw, Cable holder, Quick start guide

Disclaimer: Design & specifications subject to change without prior notice.